

Flexible nanoparticle development: process optimization & scale-up of a wide range of synthetic nanomedicines with Sunshine

Introduction

Nanomedicine is one of the most promising fields in drug delivery, with the potential to help overcome the constraints of conventional formulation approaches and find widespread applications in the development of novel drug products and therapeutics. Synthetic nanomaterials such as liposomes, lipid nanoparticles (LNPs), and polymer nanoparticles can be used in various ways to improve the solubility, stability, and bioavailability of various Active Pharmaceutical Ingredients (APIs), which in turn can increase API transport across cell membranes, as well as extending the in vivo circulation time for enhancing the efficacy and safety of the APIs.

Due to the wide range of complex physiochemical properties of APIs, from small molecule drug compounds to nucleic acids and proteins, a flexible nanoparticle generation process is beneficial to enable the formation of different particle types depending on the API in question and the desired properties. Sunshine from Unchained Labs offers an automated microfluidic approach to developing and optimizing milliliter-scale nanoparticle synthesis protocols for a range of material types and particle structures, as well as having the capability to continuously manufacture them in multi-liter quantities for pre-clinical testing.

Over the past few decades, lipid-based nanoparticles (including liposomes, lipoplexes and LNPs) and nanoparticles (NPs) of various polymers, metals and oxides have been produced by batch methods such as thin film hydration, sonication, and nanoprecipitation; however, these traditional techniques are laborious and can involve large batch volumes. Furthermore, these methods lack batch-to-batch consistency in terms of particle size, morphology, and encapsulation efficiency, which are important factors in the efficacy of the final drug formulation.

In contrast, by using microfluidic technology to combine reactants in a precise mixing geometry using stable, highly controlled, laminar flows, the reaction chemistry is highly controlled which results in the formation of NPs with significantly improved consistency. Through the use of a hydrodynamic flow focusing approach, the reaction time for nanoparticle synthesis (and therefore particle size/morphology) can be precisely and reproducibly tuned simply by varying the flow rates of the reactants into the Sunny (microfluidic chip).

Recent years have seen a rapid increase in the investigation and development of nanomedicines using particles such as LNPs for delivering vaccines and advanced therapies, with microfluidics being widely adopted as a core technique for their synthesis (Figure 1). However, previous commercially available microfluidic technologies have required users to devote significant hands-on time to conduct the

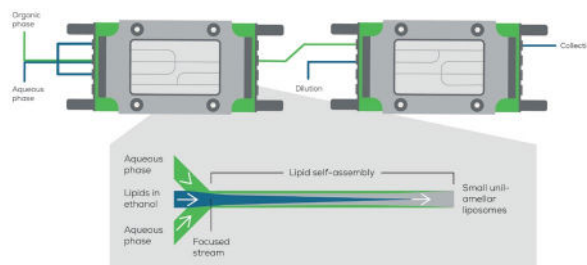

Figure 1: An example Sunny setup for the synthesis of nanoparticles, e.g. LNPs. At the first Sunny junction, in the case of LNPs, lipids in ethanol and mRNA in aqueous buffer are brought together in a laminar manner to generate a hydrodynamically focused flow of reagents. The reagents diffuse into one another reducing the solubility of the lipids which drives the self-assembly process. This mode of mixing provides highly controlled reaction conditions and results in very consistent and tunable LNP formation. An optional second Sunny is included for the in-line addition of diluent for pH adjustment and reduction of solvent concentration in collected samples.

syntheses, often involving larger reagent volumes and the use of high-cost consumables.

In order to significantly accelerate the development of nanomedicines, researchers need reliable, low-cost, and efficient nanoparticle production methods that can work flexibly with a wide range of materials. Unchained Labs' pioneering microfluidic technology is utilized in Sunshine to produce homogeneous and reproducible nanoparticles (Figure 2). With Sunshine, users can control flow rate ratio (FRR), total flow rate (TFR), precursor volume, sample collection volume and optional in-line dilution to enable the controlled, reproducible, and monodispersed formation of various nanoparticles. Sunshine not only reduces consumable cost but also provides a system which is compatible with a wide array of reagents and solvents.



Figure 2: Sunshine

This application note illustrates how Sunshine can work flexibly with multiple material types to produce nanomaterials for use in nanomedicine development. Various nanoparticles were synthesized using PLGA, two distinct liposomal formulations, and two mRNA-LNP formulations. The particles produced were all within the size range of 20 nm to 150 nm, with a polydispersity index (PDI) <0.2 and yielding encapsulation efficiencies greater than 90%. This work demonstrates that being able to precisely control and vary the FRR, TFR and degree of dilution of the reactants is central to being able to fully characterize and optimize nanoparticle synthesis and Sunshine is the ideal tool to achieve this.

Synthesis of PLGA nanoparticles with Sunshine

Poly (lactic-co-glycolic acid) (PLGA) nanoparticles are commonly used in the field of drug delivery and controlled release, owing to their biocompatibility and biodegradability. An excellent example of the use of PLGA NPs is in the delivery of ocular drugs, such as the anti-inflammatory drug triamcinolone acetonide. Encapsulation of these drugs in PLGA results in an elongated release profile which reduces the required dosage and the frequency of unpleasant drug administration processes, increasing patient compliance. Additionally, PLGA NPs exhibit unique properties, i.e. specific surface area and functionality, which enable PLGA encapsulated drugs to overcome the challenge of the ocular barrier (Jiang et al).¹

Precise control of the nanoparticle's size is crucial as size is crucial in determining the ultimate efficacy of API delivery. Traditional batch methods of PLGA NP synthesis lack reproducibility due to the inability to precisely control the reaction conditions. The result of this is typically generating particles of variable size but can also lead to uncontrolled particle aggregation, either of which will have a detrimental effect on experimental results and hamper drug discovery & development.

Parameter	Description
Aqueous Phase (A)	Deionized (DI) water
Organic Phase (O)	0.5% (w/v) PLGA in acetone
Flow Rate Ratio (FRR)	Variable (A:O)
Total Flow Rate (TFR)	3 mL/min
Sunny	Sunny 275 XT

Table 1: Parameters for the synthesis of PLGA nanoparticles using Sunshine.

¹ doi: 10.2147/IJN.S272750

Sunshine enables the rapid development of PLGA nanoparticles. In this example, a Sunny 275 XT, which mixes reagents using hydrodynamic flow focusing (HFF), was used to synthesize the nanoparticles. The size of PLGA nanoparticles was precisely and reproducibly controlled between 83 nm and 57 nm by varying the FRR from 1:1 to 8:1 (aqueous to organic phase correspondingly) while maintaining a constant TFR of 3 mL/min (Figure 3). Notably, the polydispersity index (PDI) for the produced nanoparticles averages below 0.1, indicating the monodispersity of the PLGA nanoparticles formed. This is critical for a consistent release profile for an encapsulated API.

Such PLGA particles can be further optimized using variables such as TFR, Sunny type, and by introducing stabilizing materials to the aqueous phase.

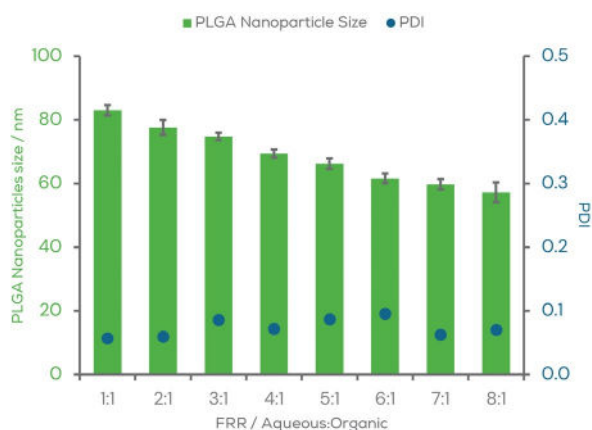

Figure 3: PLGA nanoparticles produced by varying aqueous to organic FRR at a TFR of 3 mL/min. Particle size distribution and polydispersity index (PDI) were determined by dynamic light scattering (DLS). The error bars represent standard deviation of the mean, n=3.

Using the Sunny Suite Software, users can optimize the FRR, TFR, NP precursor volume, sample collection volume and allow optional in-line dilution to synthesize controlled, reproducible, and monodispersed nanoparticles. For example, a series of 10 low-volume experiments with a fixed pair of reagents testing at various conditions of FRR, TFR, and dilution ratio could be executed automatically in 15 minutes in protocol mode.

Synthesis of liposomes with Sunshine

Liposomes are lipid-based vesicles that are formed of one or more phospholipid bilayers. They can act as biomimetic compartments with a membrane that has a significant similarity to natural cell membranes. Due to the relative simplicity of their formulation, together with excellent biocompatibility, high bioavailability, and flexibility in delivering both hydrophilic and hydrophobic APIs, liposomes have garnered growing and significant interest as a delivery system for a wide range of cargos. For these reasons, liposomes are currently the most common class of FDA-approved nanomedicines.

Parameter	Description
Aqueous Phase (A)	1x PBS, pH 7.4
Organic Phase (O)	Phospholipon 90G (1 mg/mL), DDAB (0.1 mg/mL) in ethanol
Dilution	1x PBS pH 7.4
Flow Rate Ratio (FRR)	Variable (A:O:D)
Total Flow Rate (TFR)	3 mL/min
Sunny	Sunny 100 XT, with Sunny 190 XT for dilution

Table 2: Parameters for the synthesis of phospholipon-based liposomes using Sunshine.

In this first example, the results of a liposomal synthesis using a formulation based on phospholipon 90G and a cationic lipid, dimethyl-dioctadecyl-ammonium bromide (DDAB) is reported. Unlike PLGA NP synthesis where acetone is required as a solvent, the lipid components for this liposome formulation were suspended in ethanol to form the organic input while phosphate buffered saline (1 x PBS, pH 7.4) was employed for both the aqueous and dilution inputs. When evaluating a new formulation, a rapid screen of FRR can be used effectively to explore parameters and identify both ideal and non-ideal conditions for particle formation (Figure 4).

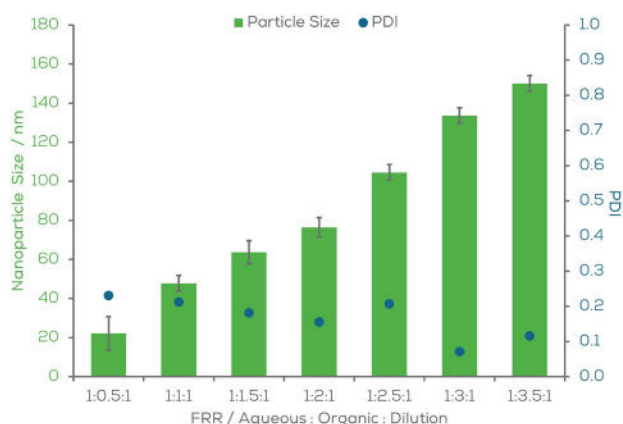

Figure 4: Phospholipon-based liposomes produced by varying aqueous to organic FRR at TFR of 3 mL/min. Liposome sizes ranged from 20 nm to 150 nm, in which particle size distribution and polydispersity index (PDI) were determined by dynamic light scattering (DLS). The error bars represent standard deviation of the mean n=3.

The results presented above show the size of the liposomes produced varying between 20 nm and 150 nm in direct response to the FRR being used. In this experiment the ratio of aqueous:organic:diluent was varied from 1:0.5:1 to 1:3.5:1, keeping the aqueous and diluent components fixed and increasing the organic component. The TFR was maintained at 3 mL/min for all experiments.

At lower organic ratios, PDIs were undesirably high, whereas a ratio of 1:3:1 gave the lowest PDI, albeit at a larger than desired particle size. A ratio of 1:2:1 gave a suitable particle size of around 80 nm, with a PDI reproducibly below 0.2. Further investigation of other conditions such as TFR, Sunny geometry, and so on, can then be investigated at this optimized flow rate ratio to further optimize PDI and other performance criteria.

A second example of liposome synthesis is shown below using a formulation of 1,2-dimyristoyl-sn-glycerol-3-phosphocholine (DMPC), cholesterol, and 1,2-dimyristoyl-rac-glycero-3-methoxypolyethyleneglycol-2000 (DSPE-PEG 2000) in a molar ratio of 2:1:0.05, respectively. For this study, the effect of TFR on liposome size was examined. Sunshine was employed in Protocol Mode to execute a batch of experiments in which the TFR was increased from 2 mL/min to 5 mL/min while maintaining a FRR of 3:1:1 (aqueous:organic:dilution).

Parameter	Description
Organic Phase (O)	DMPC: cholesterol: DMG-PEG 2000 (2:1:0.05 molar) in ethanol
Aqueous Phase (A)	PBS (Phosphate Buffered Saline) (1X, pH 7.4)
Dilution Phase (D)	PBS (Phosphate Buffered Saline) (1X, pH 7.4)
Flow Rate Ratio (FRR)	3:1:1 (A:O:D)
Total Flow Rate (TFR)	Variable
Sunny	Sunny 100 XT, with Sunny 190 XT for dilution

Table 3: Conditions to produce liposome-based DMPC: cholesterol: DMG-PEG 2000 using Sunshine with FRR at 3:1:1 (A:O:D).

The data presented in Figure 5 shows that increasing the TFR results in an 18% reduction in the hydrodynamic size of the liposomes produced, from 133 nm to 109 nm. Increasing the TFR also resulted in particles being produced with an improved, reduced PDI further highlighting the importance of assessing the response of a formulation to a range of process conditions.

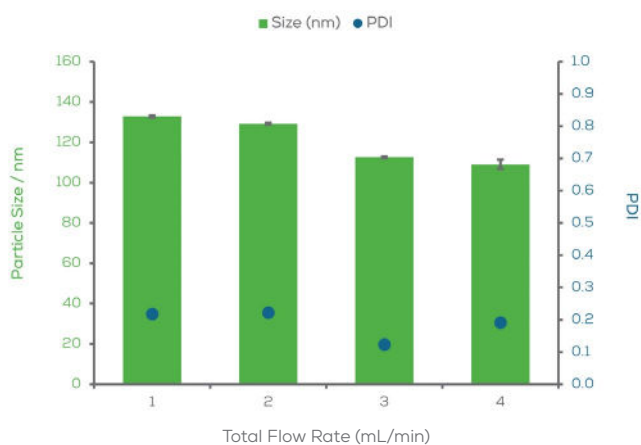

Figure 5: Conditions to produce liposomes based on DMPC, cholesterol and DMG-PEG 2000 using Sunshine with various TFRs and a fixed FRR of 3:1:1 (A:O:D). Particle size distribution and polydispersity index (PDI) were determined by dynamic light scattering (DLS). The error bars represent standard deviation of the mean, n=3.

Synthesis of lipid nanoparticles with Sunshine

Over recent years, lipid nanoparticles (LNPs) have arguably become the most significant subset of lipid-based nanocarriers. LNPs were initially derived from well-established liposome technology, with the addition of cationic or ionizable cationic lipids for encapsulation of negatively charged oligonucleotide materials, such as siRNA, mRNA, miRNA, and DNA via electrostatic interactions. The field of study has grown exponentially, and work is being conducted to fully understand the implications of formulation, composition, size, surface chemistry and a host of other parameters to enable the effective and targeted delivery of a wide range of payloads, from CRISPR therapies to mRNA vaccines.

Parameter	Description
Aqueous Phase (A)	Luciferase mRNA (4basebio PLC) in acetate buffer, pH 4
Organic Phase (O)	SM-102: DSPC: cholesterol: DMG-PEG 2000 (50:10:38.5:1.5 molar ratio) in ethanol
Dilution (D)	No dilution
Flow Rate Ratio (FRR)	Variable (A:O)
Total Flow Rate (TFR)	5 mL/min
N/P	6
Sunny	Sunny 190 XT

Table 4: Parameters for the synthesis of mRNA-LNP utilizing Sunshine.

Here, a formulation of the ionizable cationic lipid SM-102 with DSPC, cholesterol and DMG-PEG 2000, in a molar ratio of 50:10:38.5:1.5, was prepared. Luciferase mRNA (4basebio PLC) was encapsulated with a ratio of cationic lipid charge to the mRNA's phosphate negative charge (the N/P ratio) of 6. LNPs were produced using Sunshine to automatically perform a series of small volume experiments each at different FRRs while maintaining a TFR of 5 mL/min.

Figure 6 shows that the size of mRNA-LNPs formed reduced by 14.7%, from 68 nm to 58 nm, as the FRR increased from 2:1 to 6:1 (aqueous:organic). Particle size and PDI were assessed by DLS post-dialysis and a consistently low PDI was recorded for all conditions tested.

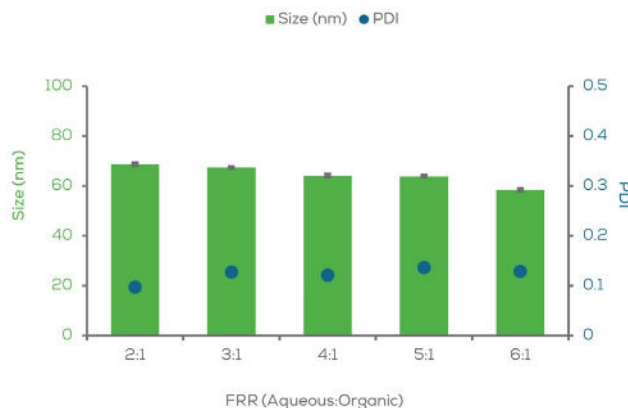

Figure 6: mRNA-LNP produced by various FRR (aqueous:organic) at a fixed TFR of 5 mL/min with no dilution. LNPs ranged from 58 nm to 68 nm post-dialysis, with an average PDI of 0.12. Particle size distribution and polydispersity index (PDI) were determined by dynamic light scattering (DLS). The error bars represent the standard deviation of the mean, n=3.

Using a Quant-it™ RiboGreen RNA Assay Kit (Thermo Fisher Scientific), hereafter 'RiboGreen', the mRNA encapsulation efficiency (EE%) was examined. While the TFR was maintained at 5 mL/min and the N/P ratio was kept constant at 6, the data in Figure 7 shows the encapsulation efficiency (EE) was above 90% for all FRRs tested with a FRR of 6:1 (aqueous:organic) providing the highest encapsulation efficiency of 96%.

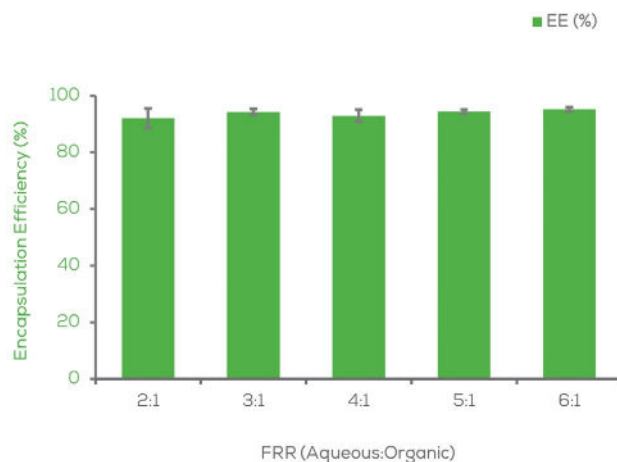

Figure 7: The mRNA encapsulation efficiency (EE%) in the LNPs produced was obtained by the RiboGreen assay. mRNA-LNPs were produced using Sunshine at a fixed TFR of 5 mL/min and various FRR (aqueous:organic) with no dilution. The N/P ratio was fixed at 6. The error bars represent standard deviation of the mean, n=3.

A second LNP formulation based on the cationic lipid DOTAP (1,2-dioleoyl-3-trimethylammonium-propane) was prepared as detailed in Table 5 below. For this work, the payload is Polyadenylic acid (Poly(A), Merck, Cat# GE27-4110-01) which is a single-stranded RNA homopolymer of the nucleotide Adenine with an average chain length of >200 nucleotides. Poly(A) has been demonstrated to be a suitable analogue for mRNA for the purpose of particle synthesis experiments (data available on request).

Parameter	Description
Aqueous Phase (A)	Poly(A) in citrate, pH 6
Organic Phase (O)	DOTAP: DSPC: cholesterol: DMG-PEG 2000 (40:10:47.5:2.5 molar) in ethanol
Dilution (D)	1x PBS, pH 7.4
Flow Rate Ratio (FRR)	3:1 (A:O)
Total Flow Rate (TFR)	Variable
N/P	8
Sunny	Sunny 490 Trident T

Table 5: Parameters for the synthesis of Poly(A)-LNP based DOTAP utilizing Sunshine.

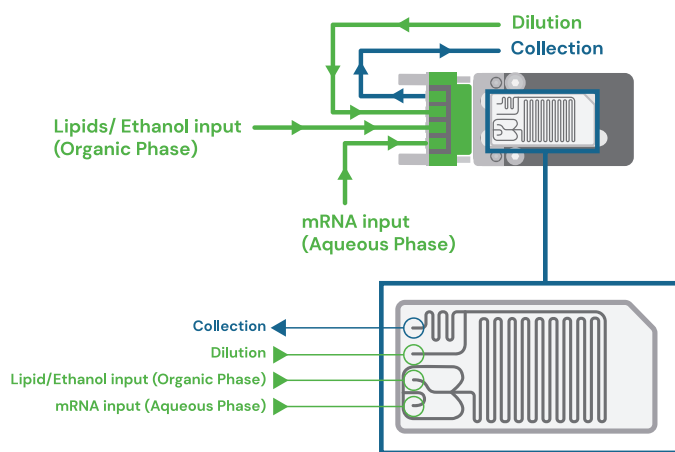

Figure 8: Sunny 490 Trident T - entry of DOTAP lipids in organic solvent and payload Poly(A) in aqueous buffer, hydrodynamic flow focusing, and subsequent mixing assembles Poly (A)-LNPs, with the option of in-line dilution. The linear connector affixes to the top surface of the Sunny, enabling the mRNA input to be split on-chip into 2 fluid streams and recombined with the lipid/ethanol input at the trident junction..

The Poly(A) was loaded into DOTAP-based LNPs which were made using Sunshine in combination with a Sunny 490 Trident T. A FRR of 3:1 (aqueous:organic) was maintained throughout a series of experiments in which the TFR was varied from 5 mL/min to 12 mL/min to explore the effect of TFR on the size and polydispersity of the nanoparticles produced. As shown in Figure 9 the Poly(A)-loaded DOTAP-based LNPs produced could be consistently and reproducibly synthesized with sizes ranging between 128 nm to 66 nm with the PDI of around 0.13.

Three replicates were performed for each TFR. All LNPs produced exhibited highly consistent sizes with PDIs below 0.2 and with a relative standard deviation (RSD) that was less than 4%, which is regarded as repeatable.

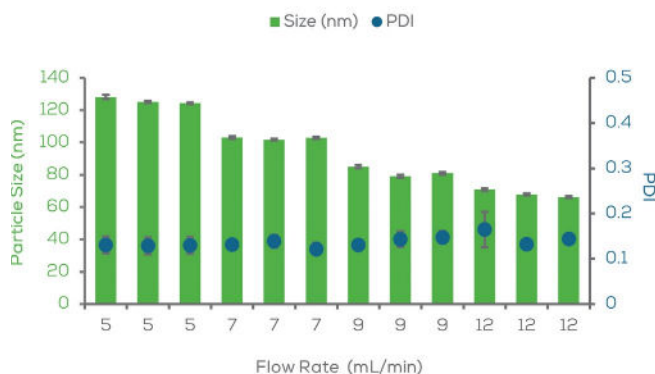

Figure 9: Poly(A) encapsulated in DOTAP-based LNPs produced at various TFRs at a fixed FRR (3:1) (aqueous:organic). LNPs ranged from 66 nm to 128 nm, with polydispersity index (PDI) values around 0.13. Particle size distribution and PDI were determined by dynamic light scattering (DLS). The error bars represent standard deviation of the mean, n=3. .

Conclusions

Due to the distinct formulation properties of the different materials used in nanoparticle synthesis, it is challenging to determine an optimization process which would be generally applicable. This has led to high demand for an all-in-one system capable of rapidly synthesizing and effectively screening process parameters to optimize nanoparticle production from a variety of nanomaterials. In addition, conventional methods of bulk synthesis typically produce nanoparticles that are not homogeneous or predictable. In fact, effective pharmacological delivery requires extremely precise and reproducible control of the particles produced, therefore particles produced by batch methods are not a particularly attractive option for the pharmaceutical industry.

Microfluidics, unlike conventional batch synthesis methods, provides the ability to manipulate particle sizes by adjusting the TFR, FRR and/or chip geometry. For example, increasing the flow rate ratio of the aqueous to organic phase, for most formulations, results in a reduction in nanoparticle size.

During the nanoparticle syntheses described here it can be seen that adjusting the FRR to increase the organic component typically results in an increase in the size of the particles produced. The formation of larger particles is driven by the higher concentration of lipids/polymer per unit volume and longer diffusion/mixing time.

Similarly, TFR also plays a critical role in determining the size of particles formed, as increasing TFR (and therefore fluid velocity & Reynolds number) through a mixing geometry will reduce mixing time, and therefore the size of the resulting nanoparticles.

Sunshine provides a unique platform for the development of nanoparticles by combining precision microfluidics and automation to rapidly screen and identify the optimal process conditions for a given formulation and nanoparticle type. With microfluidics, the resulting nanoparticles typically exhibit a much narrower size distribution when compared

to other synthesis methods and can allow for the particle size to be readily manipulated.

Sunshine can be utilized to rapidly optimize the formation of a wide variety of nanoparticles, from PLGA nanoparticles, liposomes, and ionizable or cationic-LNPs. By allowing users to define and automatically execute batches of experiments (each with different TFRs and FRRs), the optimal set of conditions for nanoparticle synthesis can be determined. Once determined these conditions can be used by Sunshine to produce volumes of nanoparticles up to 10s of liters per day in continuous mode.

Materials and methods

For the production of PLGA nanoparticles, poly (lactic-co-glycolic acid) (Sigma Aldrich, UK) was dissolved in acetone (Sigma Aldrich, UK) at a concentration of 0.5% (w/v). Deionized water was used for the aqueous phase. All formulated solutions underwent filtration using a 0.2 μm filter. A Sunny 275 XT was used for all experiments.

To produce the liposomes based on phospholipon and DDAB, phospholipon 90G (Lipoid, Switzerland) and DDAB (Fisher Scientific, UK) were dissolved in ethanol (reagent grade 99%, Sigma Aldrich, UK) at concentration of 1 mg/mL and 0.1 mg/mL respectively. For the aqueous and dilution phase, 1x PBS at pH 7.4 was used. All prepared solutions were filtered with a 0.2 μm filter prior to use. Particles were formed on a Sunny 100 XT with a second, Sunny 190 XT included in series for in-line addition of diluent.

The second liposome formulation was prepared using DMPC (Avanti, USA), cholesterol (Sigma Aldrich, UK), and DMG PEG 2000 (Avanti, USA) which were dissolved in anhydrous ethanol (Sigma Aldrich, UK) with the molar ratio of 2:1:0.05, respectively. 1x PBS at pH 7.4 was used for the aqueous phase and dilution buffer. For these liposomes, a Sunny 190 XT was used for both synthesis and in-line dilution.

SM-102-based mRNA-LNPs were synthesized using DSPC (Avanti, USA), DMG PEG-2000 (Avanti, USA), cholesterol (Sigma Aldrich, UK) was dis-

solved in ethanol to a final concentration of 10 mg/mL. SM-102 (BroadPharm, San Diego, US) was supplied as a 100 mg/mL solution in ethanol and combined with the initial lipid solution to prepare a mixture with an overall concentration of 10 mM with a relative molar ratio of 50:10:38.5:1.5 of SM-102, DSPC, cholesterol and DMG PEG-2000 respectively. For the aqueous phase, 89.44 µg/mL of mRNA (Luciferase) was dissolved in 50 mM of acetate buffer, pH 4 (nuclease-free). A Sunny 100 XT was used for LNP synthesis.

DOTAP-based LNPs were produced using DOTAP (Avanti, USA), DSPC (Avanti, USA), DMG PEG-2000 (Avanti, USA), cholesterol (Sigma Aldrich, USA). The lipid components were dissolved in ethanol to form a 10 mM solution with the molar ratio of 40:10:47.5:2.5 of DOTAP, DSPC, cholesterol and DMG PEG-2000 respectively. For the aqueous phase, 64 µg/mL of Poly(A) was prepared in 50 mM of citrate buffer, pH 6.0 (nuclease-free). A Sunny 490 Trident T was used for LNP synthesis.

For all nanoparticles prepared, the organic (ethanol or acetone) and aqueous solutions were mixed microfluidically and automatically using Sunshine to perform batches of experiments at various total flow rates and flow rate ratios.

Particle size distribution and polydispersity index (PDI) were determined by DLS. All samples were analyzed in triplicate with the mean size and standard deviation (SD) of the replicates reported.

The nanoparticles formed were dialyzed using a dialysis kit (Pur-A-lyzer™ Midi Dialysis Kit, Sigma, UK) and placed in a beaker containing 1 L of PBS 1x pH 7.4. The dialysis was run for 3 hours to remove the ethanol and exchange the buffer medium. The post-dialysis solution of nanoparticles was stored in the fridge for further investigation.

The encapsulation efficiency (EE%) of mRNA-LNP was quantified by RiboGreen assay by using Triton X-100 to break open the LNP to determine concentration of total mRNA in the sample and comparing this value to the concentration of free mRNA, determined in the absence of Triton. The fluorescence intensity of RiboGreen was measured on a Microplate reader (FLUORostar, BMG, Germany).



Unchained Labs
4747 Willow Rd,
Pleasanton, CA 94588
Phone: 1.925.587.9800
Toll-free: 1.800.815.6384
Email: info@unchainedlabs.com

© 2023 Unchained Labs. All rights reserved. The Unchained Labs logo, Sunscreen and Sunshine are trademarks and/or registered trademarks of Unchained Labs. All other brands or product names mentioned are trademarks owned by their respective organizations.